

1

Kit 5033

FORD Mondeo (Mk. V), 5-dr Estate, 15-

ISO 11154-E

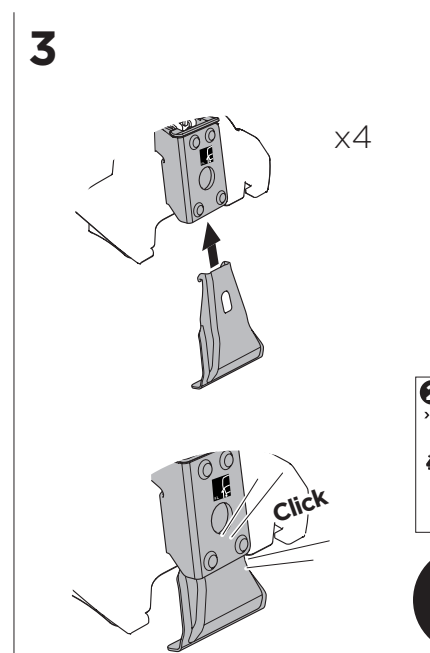
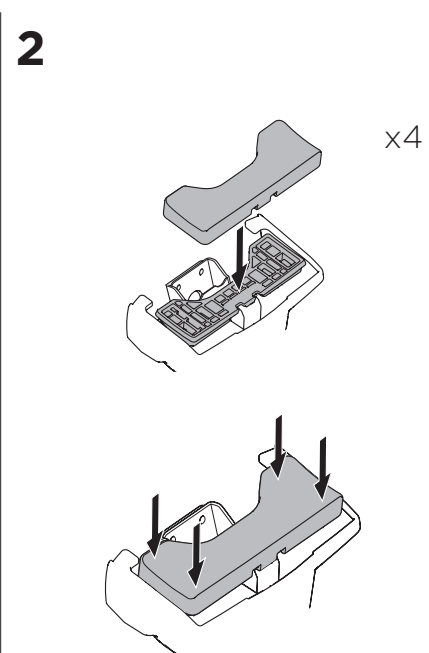
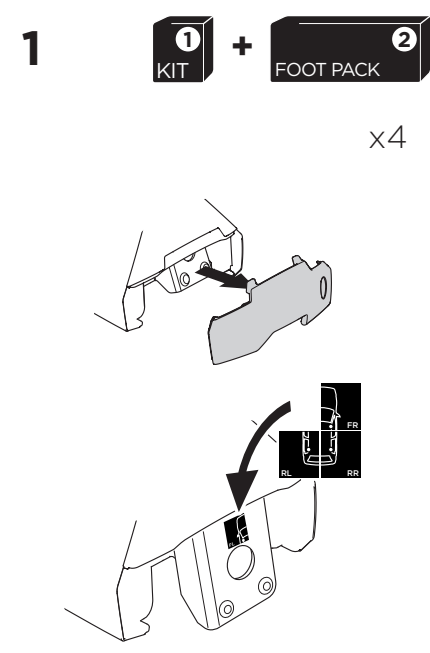
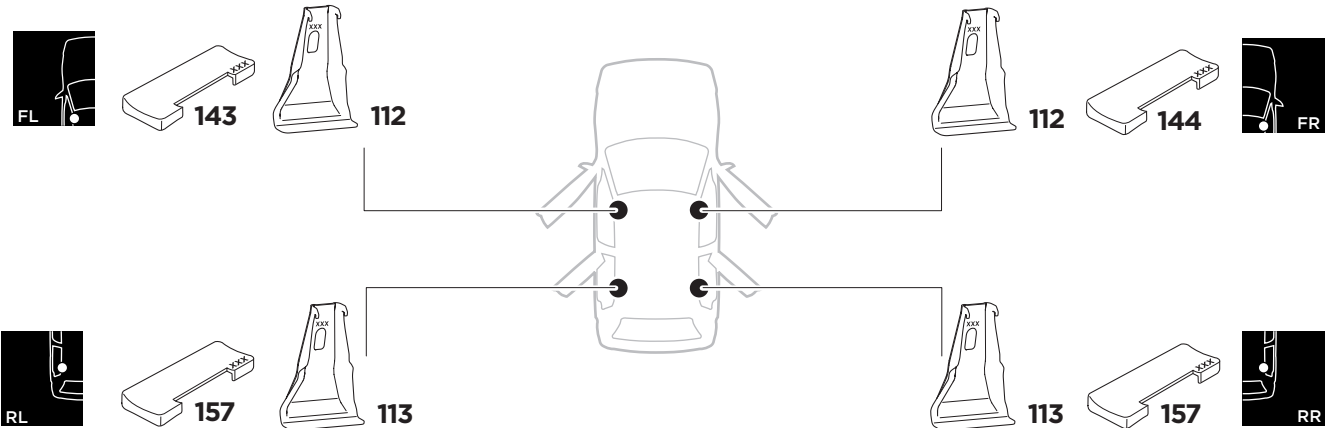
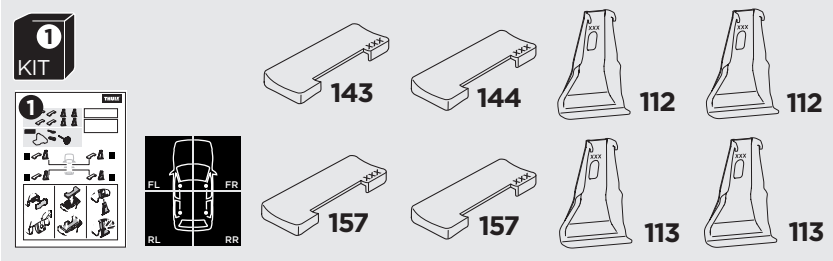



THULE WingBar Evo	THULE WingBar Edge	THULE WingBar	THULE SquareBar	Evo X (scale)	Edge X (scale)
FORD Mondeo (Mk. V), 5-dr ESTATE, 15-				48,5	R
THULE ProBar	THULE SlideBar				X (mm/inch)
FORD Mondeo (Mk. V), 5-dr ESTATE, 15-				1136 mm / 44 3/4"	



THULE WingBar Evo	THULE WingBar Edge	THULE WingBar	THULE SquareBar	Evo Y (scale)	Edge Y (scale)
FORD Mondeo (Mk. V), 5-dr ESTATE, 15-				39,5	R
THULE ProBar	THULE SlideBar				Y (mm/inch)
FORD Mondeo (Mk. V), 5-dr ESTATE, 15-				1046 mm / 41 1/8"	

	W (mm/inch)	Z (mm/inch)
FORD Mondeo (Mk. V), 5-dr ESTATE, 15-	770 mm / 30 3/8"	235 mm / 9 1/4"

